

SD300

Industrial Diesel Generator Set

EPA Certified Stationary Emergency

Standby Power Rating
375kVA 300kW 60Hz

Prime Power Rating*
338kVA 270KW 60Hz

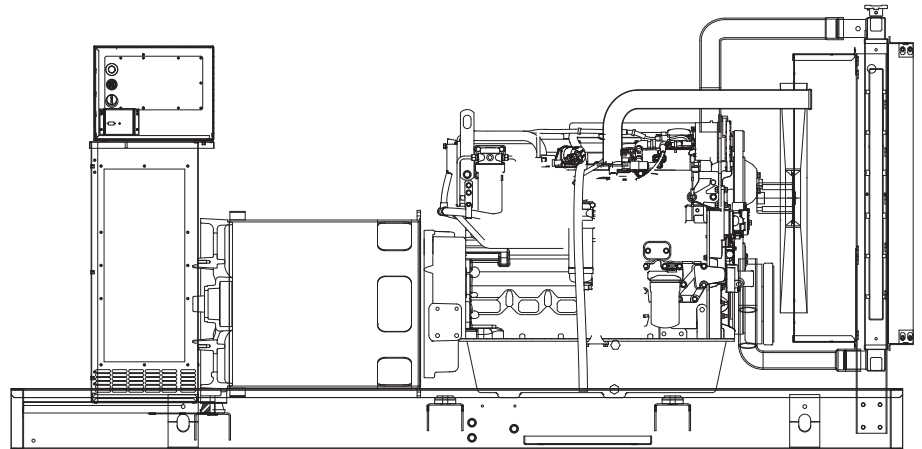

Generator image used for illustration purposes only

*EPA Certified Prime ratings are not available in the U.S. or its Territories for engine model year 2011 and beyond

features

benefits

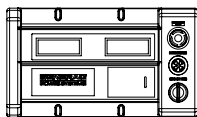
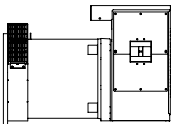
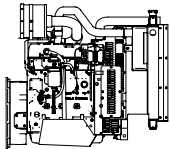
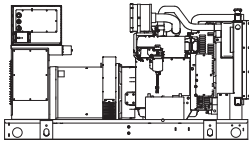

Generator Set

- PROTOTYPE & TORSIONALLY TESTED
- UL2200 TESTED
- RHINOCOAT PAINT SYSTEM
- WIDE RANGE OF ENCLOSURES AND TANKS
- ▶ PROVIDES A PROVEN UNIT
- ▶ ENSURES A QUALITY PRODUCT
- ▶ IMPROVES RESISTANCE TO ELEMENTS
- ▶ PROVIDES A SINGLE SOURCE SOLUTION

Engine

- EPA COMPLIANT
- INDUSTRIAL TESTED, GENERAC APPROVED
- POWER-MATCHED OUTPUT
- INDUSTRIAL GRADE
- ▶ ENVIRONMENTALLY FRIENDLY
- ▶ ENSURES INDUSTRIAL STANDARDS
- ▶ ENGINEERED FOR PERFORMANCE
- ▶ IMPROVES LONGEVITY AND RELIABILITY

Alternator

- TWO-THIRDS PITCH
- LAYER WOUND ROTOR & STATOR
- CLASS H MATERIALS
- DIGITAL 3-PHASE VOLTAGE CONTROL
- ▶ ELIMINATES HARMFUL 3RD HARMONIC
- ▶ IMPROVES COOLING
- ▶ HEAT TOLERANT DESIGN
- ▶ FAST AND ACCURATE RESPONSE

Controls

- ENCAPSULATED BOARD W/ SEALED HARNESS
- 4-20mA VOLTAGE-TO-CURRENT SENSORS
- SURFACE-MOUNT TECHNOLOGY
- ADVANCED DIAGNOSTICS & COMMUNICATIONS
- ▶ EASY, AFFORDABLE REPLACEMENT
- ▶ NOISE RESISTANT 24/7 MONITORING
- ▶ PROVIDES VIBRATION RESISTANCE
- ▶ HARDENED RELIABILITY

primary codes and standards



SD300

application and engineering data

ENGINE SPECIFICATIONS

General

Make	Iveco/FPT
EPA Emissions Compliance	Stationary Emergency
EPA Emissions Reference	See Emissions Data Sheet
Cylinder #	6
Type	In-Line
Displacement - L	10.3
Bore - mm (in.)	125 (4.92)
Stroke - mm (in.)	140 (5.51)
Compression Ratio	16.5:1
Intake Air Method	Turbocharged/Aftercooled
Cylinder Head Type	4- Valve
Piston Type	Aluminum
Crankshaft Type	Dropped Forged Steel

Engine Governing

Governor	Electronic Isochronous
Frequency Regulation (Steady State)	± 0.25%

Lubrication System

Oil Pump Type	Gear
Oil Filter Type	Full-Flow
Crankcase Capacity - L (qts)	30 (31.68)

Cooling System

Cooling System Type	Closed Recovery
Water Pump Flow	Pre-Lubed, Self Sealing
Fan Type	Pusher
Fan Speed (rpm)	2250 rpm
Fan Diameter mm (in.)	762 (30.0)
Coolant Heater Standard Wattage	2000
Coolant Heater Standard Voltage	240VAC

Fuel System

Fuel Type	Ultra Low Sulfur Diesel Fuel
Fuel Specifications	ASTM
Fuel Filtering (microns)	5
Fuel Inject Pump Make	Electronic
Fuel Pump Type	Engine Driven Gear
Injector Type	Common Rail
Engine Type	Direct Injection
Fuel Supply Line - mm (in.)	12.7 (½")
Fuel Return Line - mm (in.)	12.7 (½")

Engine Electrical System

System Voltage	24VDC
Battery Charging Alternator	Std
Battery Size (at 0°C)	1155 CCA
Battery Group	8D
Battery Voltage	(2) - 12VDC
Ground Polarity	Negative

ALTERNATOR SPECIFICATIONS

Standard Model	520 mm Generac
Poles	4
Field Type	Revolving
Insulation Class - Rotor	H
Insulation Class - Stator	H
Total Harmonic Distortion	< 5%
Telephone Interference Factor (TIF)	< 50
Standard Excitation	Permanent Magnent
Bearings	Single Sealed Cartridge
Coupling	Direct, Flexible Disc
Load Capacity - Standby	100%
Prototype Short Circuit Test	Yes

Voltage Regulator Type	Digital
Number of Sensed Phases	All
Regulation Accuracy (Steady State)	± 0.25%

CODES AND STANDARDS COMPLIANCE (WHERE APPLICABLE)

NFPA 99	BS5514
NFPA 110	SAE J1349
ISO 8528-5	DIN6271
ISO 1708A.5	IEEE C62.41 TESTING
ISO 3046	NEMA ICS 1

Rating Definitions:

Standby – Applicable for a varying emergency load for the duration of a utility power outage with no overload capability. (Max. load factor = 70%)

Prime – Applicable for supplying power to a varying load in lieu of utility for an unlimited amount of running time. (Max. load factor = 80%) A 10% overload capacity is available for 1 out of every 12 hours.

SD300

operating data (60Hz)

POWER RATINGS (kW)

	STANDBY		PRIME	
Single-Phase 120/240VAC @1.0pf	300 kW	Amps: 1250	270 kW	Amps: 1125
Three-Phase 120/208VAC @0.8pf	300 kW	Amps: 1041	270 kW	Amps: 937
Three-Phase 120/240VAC @0.8pf	300 kW	Amps: 902	270 kW	Amps: 812
Three-Phase 277/480VAC @0.8pf	300 kW	Amps: 451	270 kW	Amps: 406
Three-Phase 346/600VAC @0.8pf	300 kW	Amps: 361	270 kW	Amps: 325

STARTING CAPABILITIES (sKVA)

		sKVA vs. Voltage Dip											
		480VAC						208/240VAC					
Alternator	kW	10%	15%	20%	25%	30%	35%	10%	15%	20%	25%	30%	35%
Standard	300	303	454	605	757	908	1059	227	341	454	568	681	794
Upsize 1	400	387	581	775	968	1162	1356	345	570	835	1100	1450	1710
Upsize 2	500	457	686	914	1143	1371	1600	-	-	-	-	-	-

FUEL

		Fuel Consumption Rates*					
		STANDBY			PRIME		
		Percent Load	gph	lph	Percent Load	gph	lph
Fuel Pump Lift - in (mm)	36 (900)						
Total Fuel Pump Flow (Combustion + Return)	31 gph						
		25%	7.6	28.7	25%	6.9	26.1
		50%	12.6	47.7	50%	11.6	43.9
		75%	17.4	65.9	75%	15.8	59.8
		100%	22.1	83.7	100%	19.9	75.3

* Refer to "Emissions Data Sheet" for maximum fuel flow for EPA and SCAQMD permitting purposes.

COOLING

		STANDBY	PRIME
Coolant Flow per Minute	gpm (lpm)	95 (360)	95 (360)
Heat Rejection to Coolant	BTU/hr	814,783	733,673
Inlet Air	cfm (m3/min)	14,505 (411)	14,505 (411)
Max. Operating Radiator Air Temp	F° (C°)	122 (50)	122 (50)
Max. Operating Ambient Temperature	F° (C°)	104 (40)	104 (40)
Coolant System Capacity	gal (L)	16.6 (63)	16.6 (63)
Maximum Radiator Backpressure	in H ₂ O	1.5	1.5

COMBUSTION AIR REQUIREMENTS

		STANDBY	PRIME
Flow at Rated Power	cfm (m3/min)	850 (24.07)	765 (21.67)

ENGINE

		STANDBY	PRIME
Rated Engine Speed	rpm	1800	1800
Horsepower at Rated kW**	hp	480	432
Piston Speed	ft/min	1654	1654
BMEP	psi	336	302

** Refer to "Emissions Data Sheet" for maximum bHP for EPA and SCAQMD permitting purposes.

EXHAUST

		STANDBY	PRIME
Exhaust Flow (Rated Output)	cfm (m ³ /min)	2240 (63.4)	2016 (57.1)
Max. Backpressure (Post Silencer)	inHg (Kpa)	1.5 (5.1)	1.5 (5.1)
Exhaust Temp (Rated Output)	°F (°C)	1020 (549)	918 (492)
Exhaust Outlet Size (Open Set)	NPT (male)	101.6 (4)	101.6 (4)

Deration – Operational characteristics consider maximum ambient conditions. Derate factors may apply under atypical site conditions. Please consult a Generac Power Systems Industrial Dealer for additional details. All performance ratings in accordance with ISO3046, BS5514, ISO8528 and DIN6271 standards.

SD300

standard features and options

GENERATOR SET



- Genset Vibration Isolation Std
- IBC Seismic Certified/Seismic Rated Vibration Isolators Opt
- Extended warranty Opt
- Gen-Link Communications Software Opt
- Steel Enclosure Opt
- Aluminum Enclosure Opt

ENGINE SYSTEM



General

- Oil Drain Extension Std
- Oil Make-Up System Opt
- Oil Heater Opt
- Air cleaner Std
- Fan guard Std
- Radiator duct adapter Std

Fuel System

- Fuel lockoff solenoid Std
- Secondary fuel filter Std
- Stainless steel flexible exhaust connection Std
- Industrial Exhaust Silencer Std
- Critical Exhaust Silencer Opt
- Flexible fuel lines Opt
- Primary fuel filter Opt
- Single Wall Tank (Export Only) -
- UL 142 Fuel Tank Opt

Cooling System

- 120VAC Coolant Heater Opt
- 208VAC Coolant Heater Opt
- 240VAC Coolant Heater Std
- Other Coolant Heater -
- Closed Coolant Recovery System Std
- UV/Ozone resistant hoses Std
- Factory-Installed Radiator Std
- Radiator Drain Extension Std

Engine Electrical System

- Battery charging alternator Std
- Battery cables Std
- Battery tray Std
- Battery box Opt
- Battery heater Opt
- Solenoid activated starter motor Std
- 10A UL float/equalize battery charger Opt
- Rubber-booted engine electrical connections Std

ALTERNATOR SYSTEM



- UL2200 GENprotect™ Std
- Main Line Circuit Breaker Opt
- 2nd Circuit Breaker Opt
- 3rd Circuit Breaker -
- Alternator Upsizing Opt
- Anti-Condensation Heater Opt
- Tropical coating Opt
- Permanent Magnet Generator Std

CONTROL SYSTEM

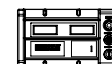

Control Panel

- Digital H Control Panel - Dual 4x20 Display Std
- Digital G-100 Control Panel - Touchscreen na
- Digital G-200 Paralleling Control Panel - Touchscreen na
- Programmable Crank Limiter Std
- 21-Light Remote Annunciator Opt
- Remote Relay Panel (8 or 16) Opt
- 7-Day Programmable Exerciser Std
- Special Applications Programmable PLC Std
- RS-232 Std
- RS-485 Std
- All-Phase Sensing DVR Std
- Full System Status Std
- Utility Monitoring (Req. H-Transfer Switch) Std
- 2-Wire Start Compatible Std
- Power Output (kW) Std
- Power Factor Std
- Reactive Power Std
- All phase AC Voltage Std
- All phase Currents Std
- Oil Pressure Std
- Coolant Temperature Std
- Coolant Level Std
- Oil Temperature Opt
- Fuel Pressure Std
- Engine Speed Std
- Battery Voltage Std
- Frequency Std
- Date/Time Fault History (Event Log) Std
- Low-Speed Exercise -
- Isochronous Governor Control Std
- 40deg C - 70deg C Operation Std
- Waterproof Plug-In Connectors Std
- Audible Alarms and Shutdowns Std
- Not in Auto (Flashing Light) Std
- Auto/Off/Manual Switch Std
- E-Stop (Red Mushroom-Type) Std
- Remote E-Stop (Break Glass-Type, Surface Mount) Opt
- Remote E-Stop (Red Mushroom-Type, Surface Mount) Opt
- Remote E-Stop (Red Mushroom-Type, Flush Mount) Opt
- NFPA 110 Level I and II (Programmable) Std
- Remote Communication - RS232 Std
- Remote Communication - Modem Opt
- Remote Communication - Ethernet Opt
- 10A Run Relay Opt

Alarms (Programmable Tolerances, Pre-Alarms and Shutdowns)

- Low Fuel Opt
- Oil Pressure (Pre-programmed Low Pressure Shutdown) Std
- Coolant Temperature (Pre-programmed High Temp Shutdown) Std
- Coolant Level (Pre-programmed Low Level Shutdown) Std
- Oil Temperature Std
- Engine Speed (Pre-programmed Overspeed Shutdown) Std
- Voltage (Pre-programmed Overvoltage Shutdown) Std
- Battery Voltage Std

Other Options

-
-
-

SD300

dimensions, weights and sound levels

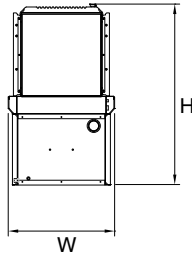
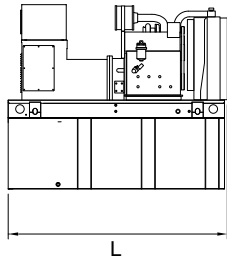

OPEN SET

RUN TIME HOURS	USABLE CAPACITY (GAL)	L	W	H	WT	dBA*
NO TANK	-	136	58	68	6088	89
8	183	136	58	81	7036	
20	438	136	58	93	7348	
31	693	136	58	105	7651	
43	946	208	58	108	9295	
60	1325	278	58	108	10128	

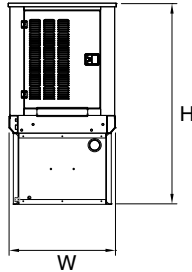
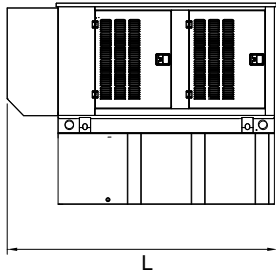

WEATHERPROOF ENCLOSURE

RUN TIME HOURS	USABLE CAPACITY (GAL)	L	W	H	WT	dBA*
NO TANK	-	175	58	78	8106	84
8	183	175	58	91	9054	
20	438	175	58	103	9366	
31	693	175	58	115	9669	
43	946	208	58	118	11313	
60	1325	278	58	118	12146	

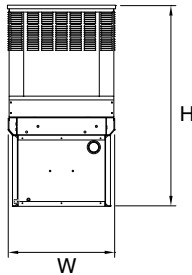
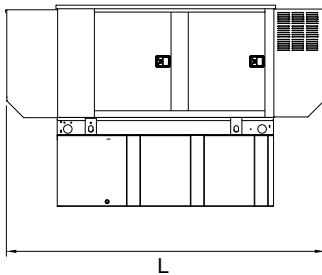

LEVEL 1 SOUND ENCLOSURE

RUN TIME HOURS	USABLE CAPACITY (GAL)	L	W	H	WT	dBA*
NO TANK	-	200	58	78	8479	78
8	183	200	58	91	9427	
20	438	200	58	103	9739	
31	693	200	58	115	10042	
43	946	234	58	118	11686	
60	1325	304	58	118	12519	

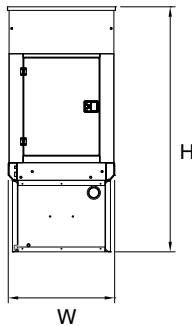
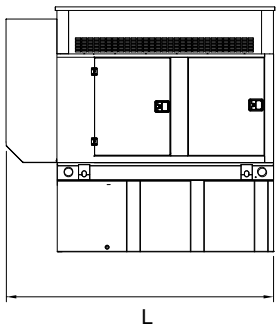

LEVEL 2 SOUND ENCLOSURE

RUN TIME HOURS	USABLE CAPACITY (GAL)	L	W	H	WT	dBA*
NO TANK	-	181	58	107	7988	75
8	183	181	58	120	8936	
20	438	181	58	132	9248	
31	693	181	58	144	9551	
43	946	208	58	147	11195	
60	1325	278	58	147	12028	

*All measurements are approximate and for estimation purposes only. Weights are without fuel in tank. Sound levels measured at 23ft (7m) and does not account for ambient site conditions.

Tank Options

<input type="radio"/> MDEQ	OPT
<input type="radio"/> Florida DERM/DEP	OPT
<input type="radio"/> Chicago Fire Code	OPT
<input type="radio"/> IFC Certification	CALL
<input type="radio"/> ULC	CALL

Other Custom Options Available from your Generac Industrial Power Dealer

YOUR FACTORY RECOGNIZED GENERAC INDUSTRIAL DEALER

Specification characteristics may change without notice. Dimensions and weights are for preliminary purposes only. Please consult a Generac Power Systems Industrial Dealer for detailed installation drawings.